

043-C: Shake Smart

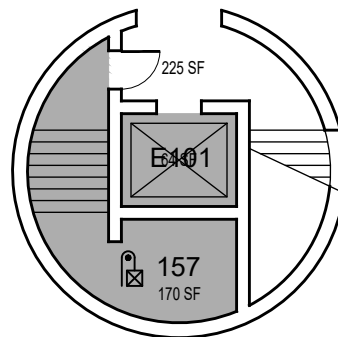

043-A: KINESIOLOGY

March 2022

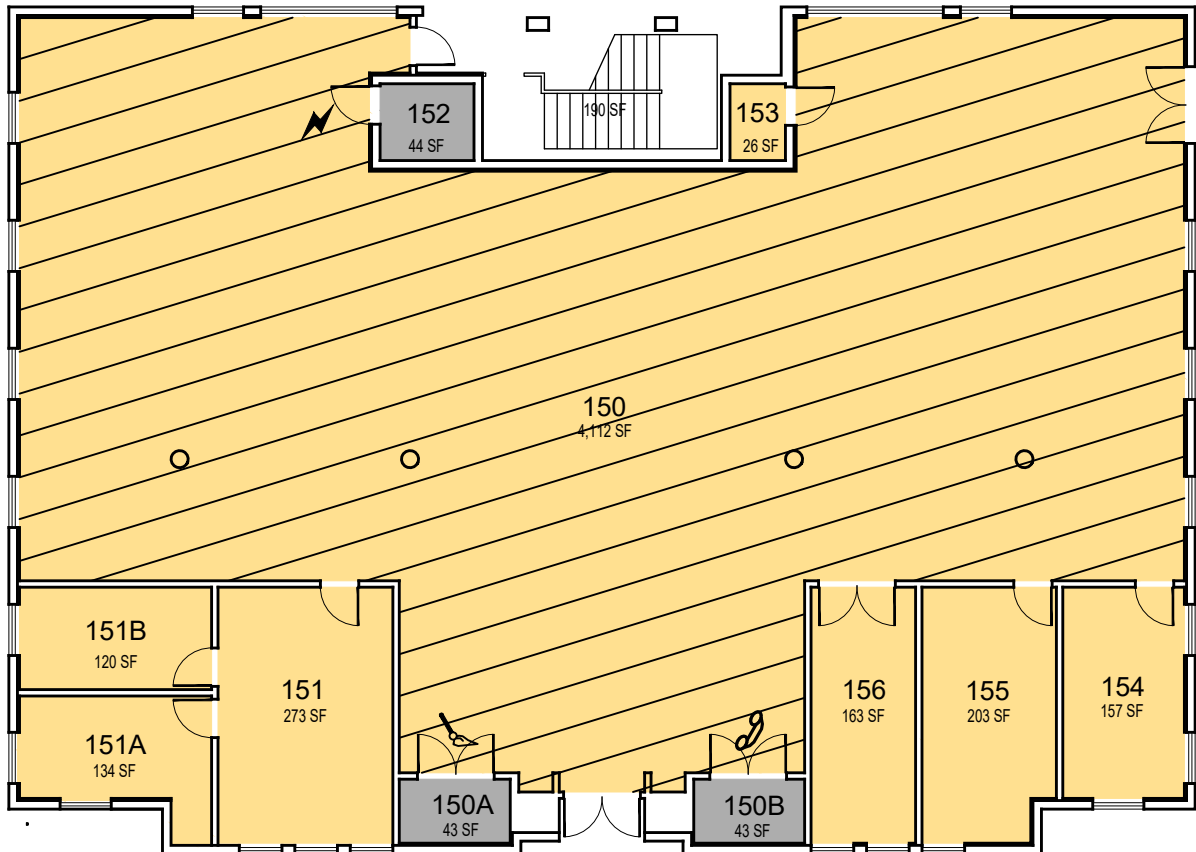

# Kinesiology

Floor 1

00000 UNASSIGN	107500 OCOB	120000 ACAD AFRS	137500 UNIV DEV	120600 RESEARCH
102500 CAFES	110000 CLA	120400 ITS	140000 STUD AFRS	120800 ENROLL
105000 CAED	112500 CENG	121300 DIV/INCL	145000 PRESIDENT	130000 PERSON
117500 CSM	125000 AFD	150000 UNIV SUP	160000 COM&MARK	



1"=15'

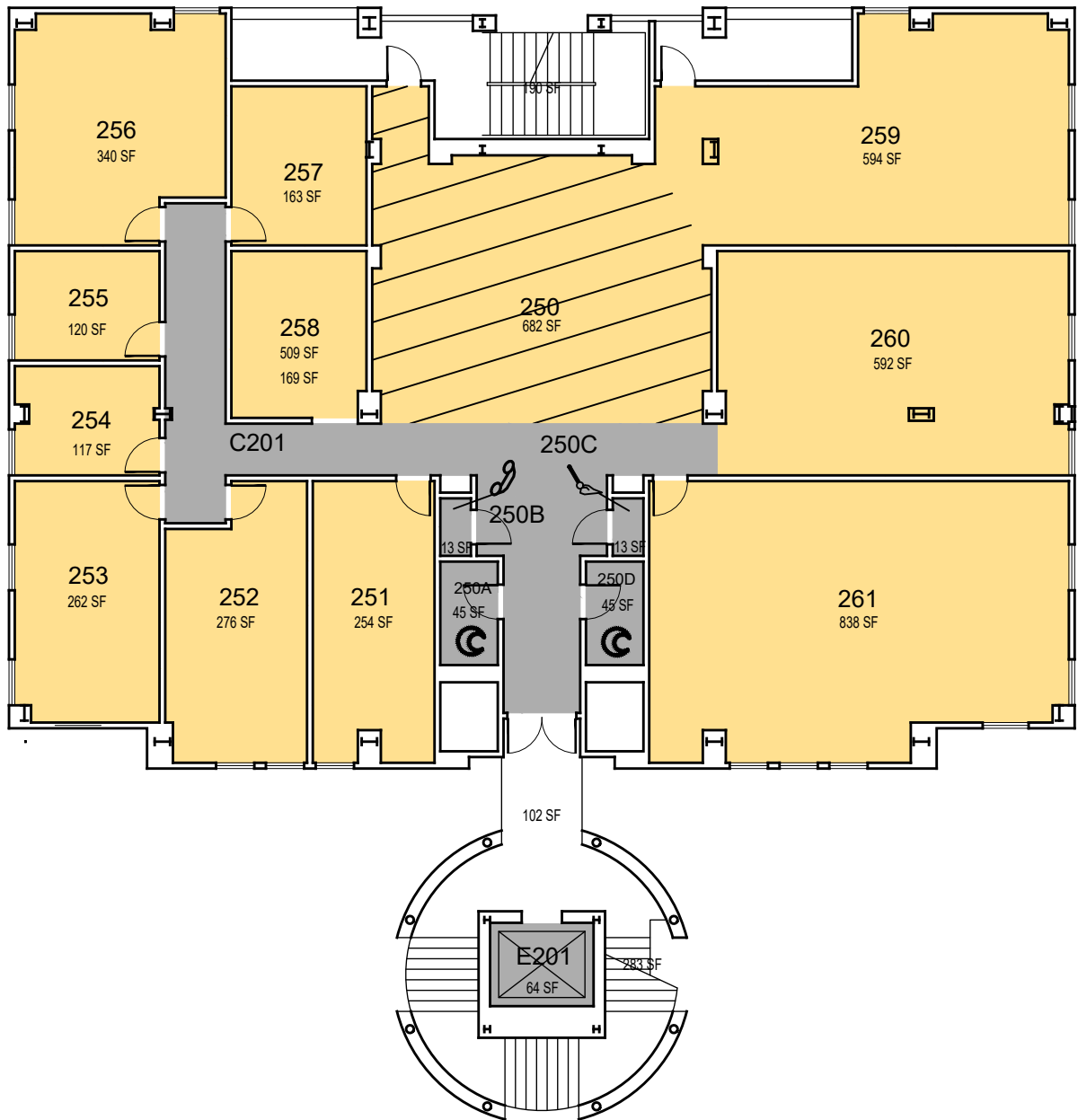

# Kinesiology

Floor 2

FACILITIES MANAGEMENT AND DEVELOPMENT

Space Data [http://afd.calpoly.edu/facilities/spacefacility/space\\_data.asp](http://afd.calpoly.edu/facilities/spacefacility/space_data.asp)

000000 UNASSIGN	107500 OCOB	120000 ACAD AFRS	137500 UNIV DEV	120600 RESEARCH
102500 CAFES	110000 CLA	120400 ITS	140000 STUD AFRS	120800 ENROLL
105000 CAED	112500 CENG	121300 DIV/INCL	145000 PRESIDENT	130000 PERSON
117500 CSM	125000 AFD	150000 UNIV SUP	160000 COM&MARK	

March 2022

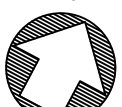

1"=15'

College/Division

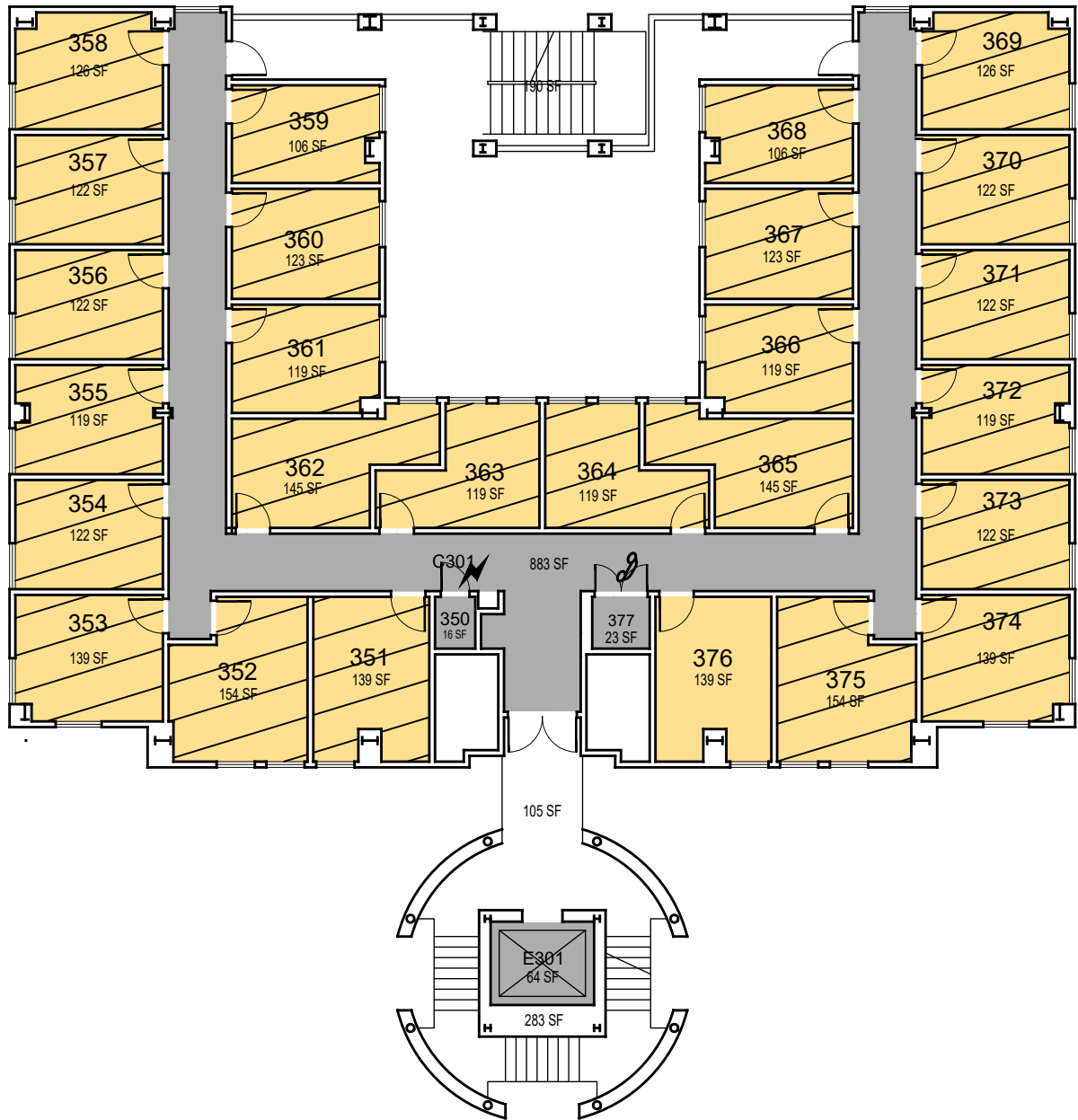

# Kinesiology

Floor 3

FACILITIES MANAGEMENT AND DEVELOPMENT

000000 UNASSIGN	107500 OCOB	120000 ACAD AFRS	137500 UNIV DEV	120600 RESEARCH
102500 CAFES	110000 CLA	120400 ITS	140000 STUD AFRS	120800 ENROLL
105000 CAED	112500 CENG	121300 DIV/INCL	145000 PRESIDENT	130000 PERSON
117500 CSM	125000 AFD	150000 UNIV SUP	160000 COM&MARK	

March 2022

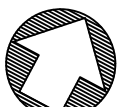

1"=15'

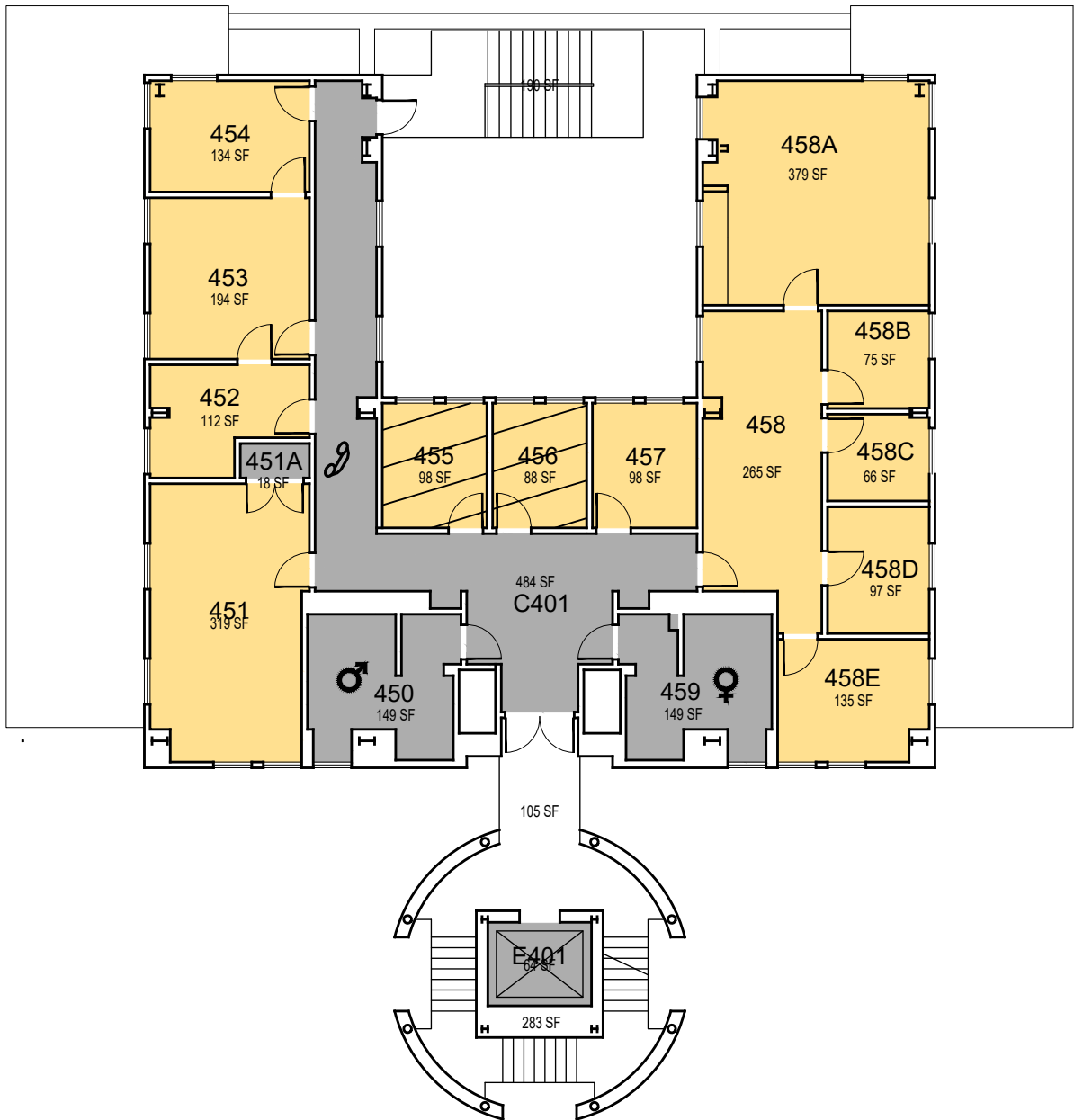

# Kinesiology

Floor 4

FACILITIES MANAGEMENT AND DEVELOPMENT

00000 UNASSIGN	107500 OCOB	120000 ACAD AFRS	137500 UNIV DEV	120600 RESEARCH
102500 CAFES	110000 CLA	120400 ITS	140000 STUD AFRS	120800 ENROLL
105000 CAED	112500 CENG	121300 DIV/INCL	145000 PRESIDENT	130000 PERSON
117500 CSM	125000 AFD	150000 UNIV SUP	160000 COM&MARK	

March 2022

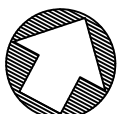

1"=15'

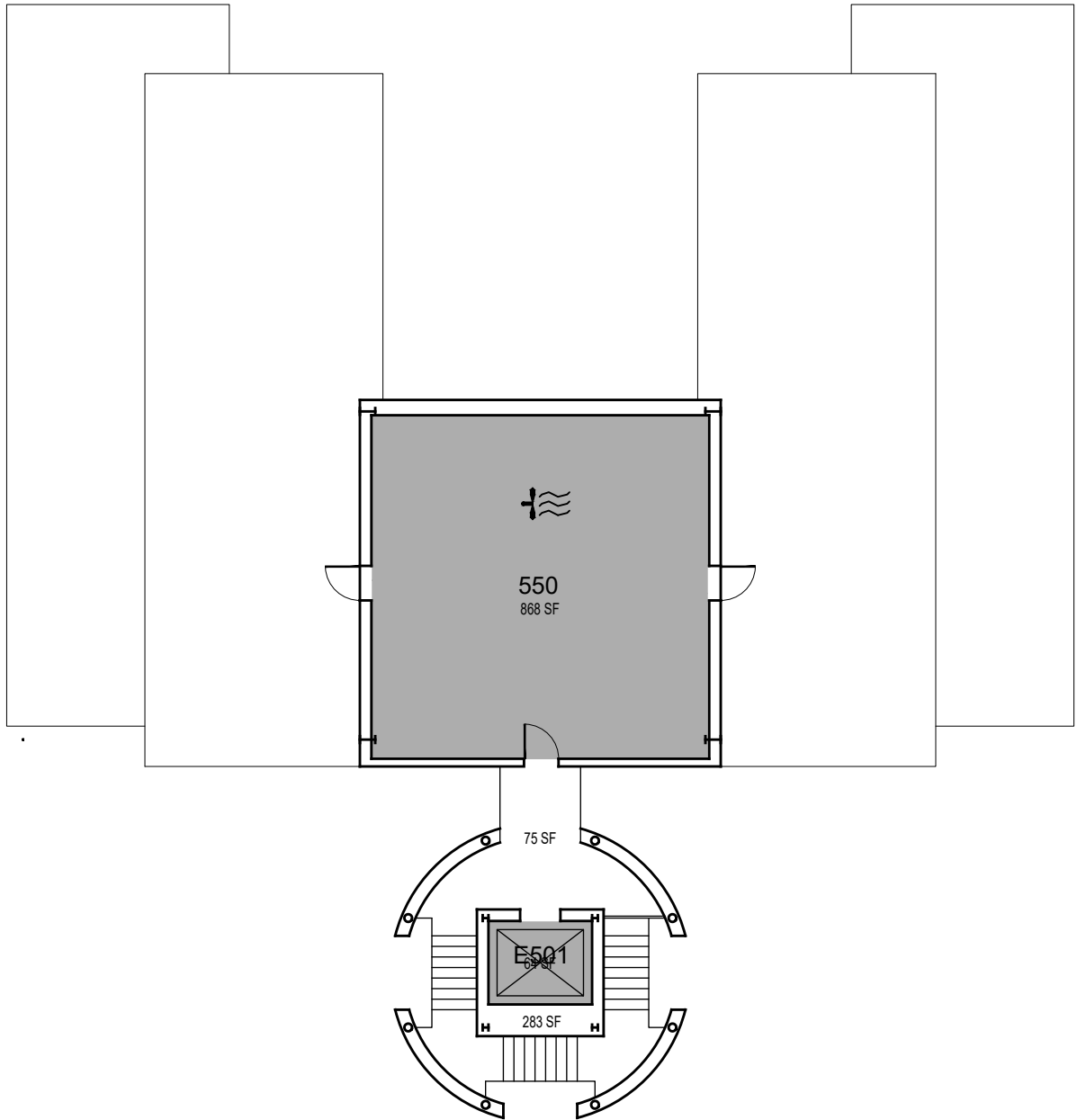

Kinesiology  
Mechanical Penthouse

000000 UNASSIGN	107500 OCOB	120000 ACAD AFRS	137500 UNIV DEV	120600 RESEARCH
102500 CAFES	110000 CLA	120400 ITS	140000 STUD AFRS	120800 ENROLL
105000 CAED	112500 CENG	121300 DIV/INCL	145000 PRESIDENT	130000 PERSON
117500 CSM	125000 AFD	150000 UNIV SUP	160000 COM&MARK	

March 2022

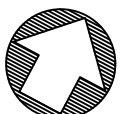

1"=15'